

Name: _____

Period: _____ Date: _____

Volume of Pyramids

Section I. Find the volume of the given solid.

1.

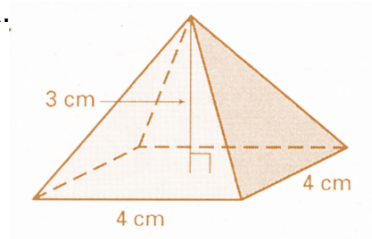

2.

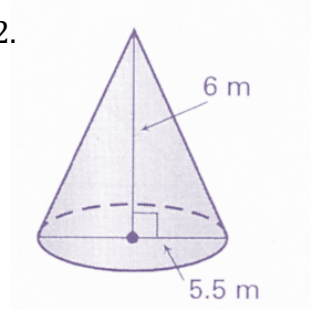

3.

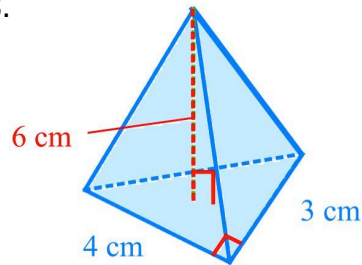

4.

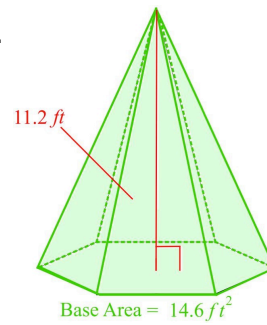

5.

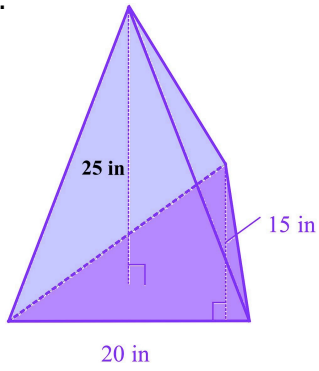

6.

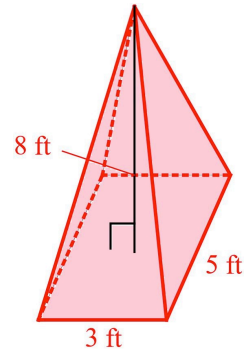

7.

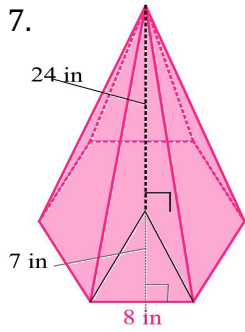

8.

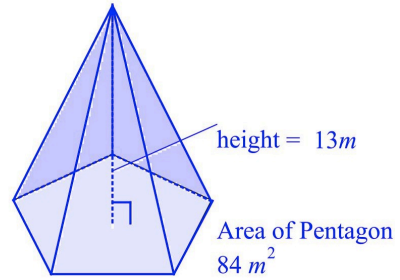

9.

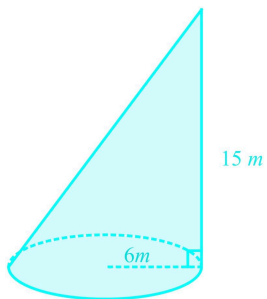

10.

